

# Mystic Falls™

## Illuminated Waterfall Weirs

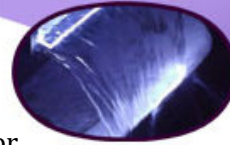

*Practical Beauty For Your Pond or Water Garden*

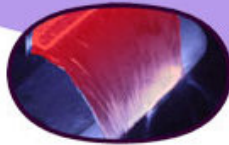
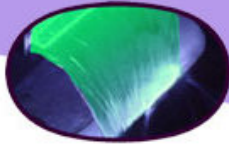
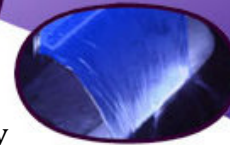

The *Mystic Falls™* line of illuminated waterfall weirs offer instant beauty to any pond or water garden in a functional form that provides for the use of filter media for beautiful crystal clear cascades of color.

They are available in four standard sizes: 8", 12", 16" and 20" (24", 36" available by special order) with a choice of five colors to choose from. White, Red, Green, Blue and Amber Array colors are available. Lighting arrays use cool, energy-efficient LEDs that make your waterfall sparkle with light. LED arrays are removable for cleaning ease and if no lighting is desired. Weirs are also available without an LED array (STW model prefix)

Additional colors may be purchased and interchanged for added flexibility. Installation is simple and offers standard pipe thread input from 1" to 1 ½" inputs with weir head flow capacities from 1400 – 3500 GPH, depending on model.

Illuminated cascades for fountains are available (ILF Models) upon request and provide a touch of elegance to any fountain. Fountain cascades have a sleek profile for use in clean water applications.

Fabricated from 3/16" durable UL90 weather resistant rigid PVC to last for many years.

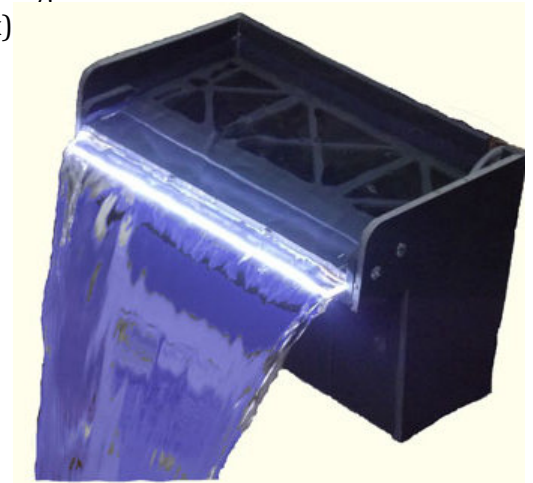

LED array refracting plates are made from optically clear acrylic and are removable for easy cleaning.

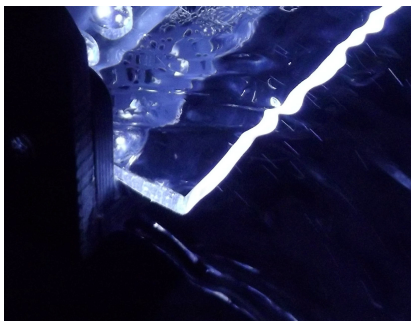

*Eloquence*

*Sophistication*

*Style*

Manufactured by:  
Aquility Systems, Inc.  
6949 SW 21st Ln.  
Gainesville, FL 32607  
(352) 332-1549



Made in America by American Workers

# Product Specifications

Model Number	Input Voltage	Total Dissipation	Flow Rate (GPH)
ILW-8W	110VAC	4 watts	1400
ILW-8R	110VAC	2 watts	1400
ILW-8G	110VAC	2 watts	1400
ILW-8B	110VAC	4 watts	1400
ILW-8A	110VAC	2 watts	1400
ILW-12W	110VAC	6 watts	2100
ILW-12R	110VAC	3 watts	2100
ILW-12G	110VAC	3 watts	2100
ILW-12B	110VAC	5.5 watts	2100
ILW-12A	110VAC	3 Watts	2100
ILW-16W	110VAC	7.5 watts	2800
ILW-16R	110VAC	3.5 watts	2800
ILW-16G	110VAC	3.5 watts	2800
ILW-16B	110VAC	7.5 watts	2800
ILW-16A	110VAC	4 watts	2800
ILW-20W	110VAC	9.5 watts	3500
ILW-20R	110VAC	4.5 watts	3500
ILW-20G	110VAC	4.5 watts	3500
ILW-20B	110VAC	9.5 watts	3500
ILW-20A	110VAC	5 watts	3500

## Dimensions

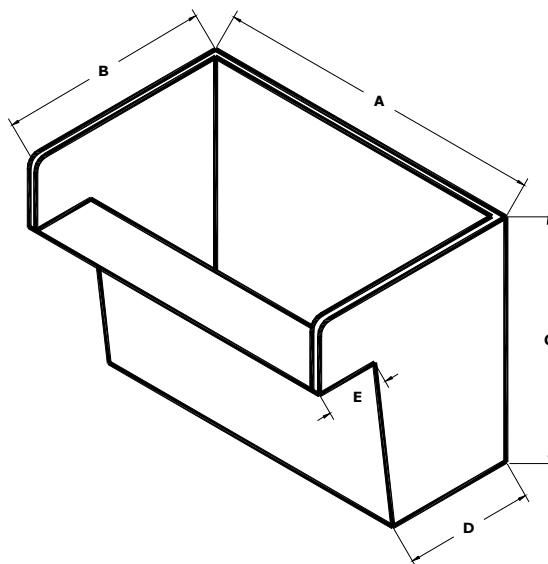

	A	B	C	D	E	Input
ILW-8	8.313"	4.94"	6"	3"	1.56"	1" FPT
ILW-12	12.313"	6.27"	7"	4"	1.90"	1" FPT
ILW-16	16.313"	7.67"	8"	5"	2.22"	1 ½" FPT
ILW-20	20.313"	9.22"	9"	6"	2.56"	1 ½" FPT

\* Some dimensions rounded.

Manufactured by:  
 Aquility Systems, Inc.  
 6949 SW 21st Ln.  
 Gainesville, FL 32607  
 (352) 332-1549



Made in America by American Workers